

Doplňující vyobrazení

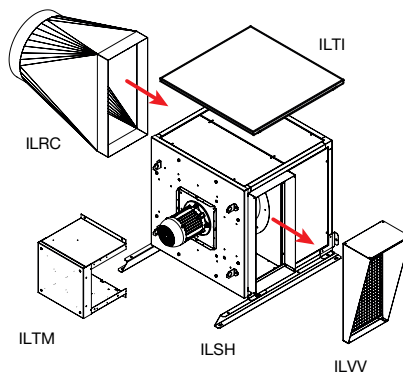

příslušenství - provedení CC

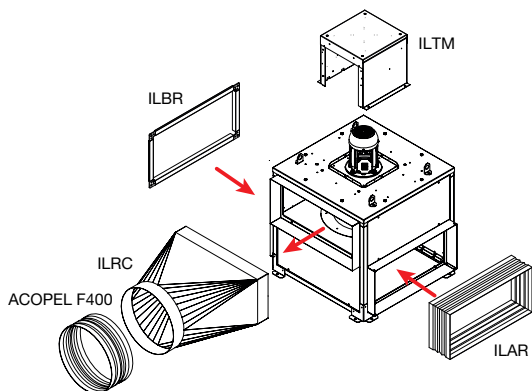
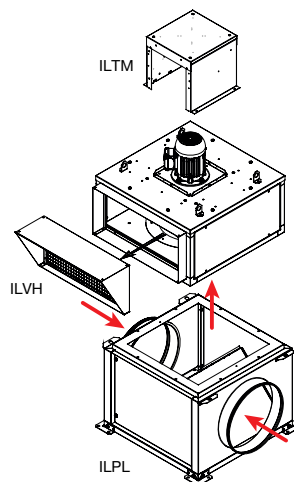
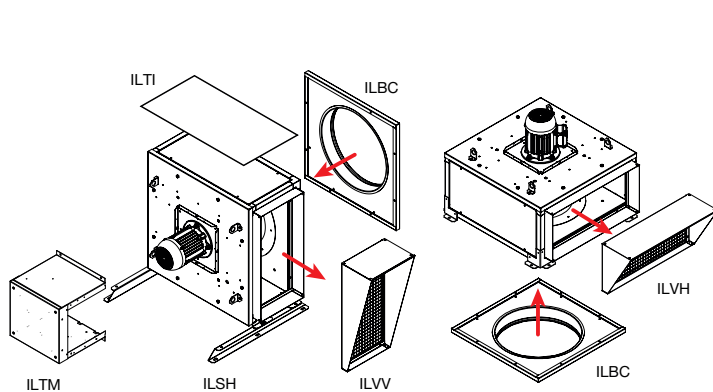

příslušenství - provedení MV

Příslušenství EL

**VFVN**
frekvenční měniče**TDP D**
diferenční tlakový
snímač**AIRSENS**
Inteligentní samostatná
prostorová čidla CO₂, RH
a VOC**MSD**
třífázový motorový
spouštěč pro zapínání a
vypínání ventilátorů**CPFL-S / CPFL-E**
detektor pohybu**HIG, HYG**
hygrostaty

Příslušenství VZT

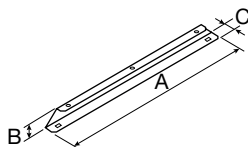

- **ILSH MV, CC**
- montážní konzola
- pro motor v horizontální poloze

14

Typ	MV			CC		
	A [mm]	B [mm]	C [mm]	A [mm]	B [mm]	C [mm]
ILSH 355	668	50	35	848	50	35
ILSH 400	668	50	35	823	50	35
ILSH 450	668	50	35	1048	50	35
ILSH 500	762	50	35	1097	50	35
ILSH 560	762	50	35	1197	50	35
ILSH 630	855	50	35	1242	50	35
ILSH 710	977	50	35	1401	50	35
ILSH 800	962	65	35	1437	65	35

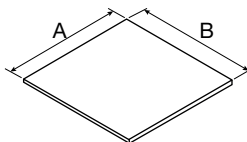

- **ILTI MV, CC**
- střeška pro venkovní použití
- pro motor v horizontální poloze

Typ	MV		CC	
	A [mm]	B [mm]	A [mm]	B [mm]
ILTI 355	658	391	658	636
ILTI 400	731	425	731	721
ILTI 450	812	453	812	790
ILTI 500	890	485	890	828
ILTI 560	985	504	985	859
ILTI 630	1098	550	1098	953
ILTI 710	1226	610	1226	1112
ILTI 800	1368	674	1368	1164

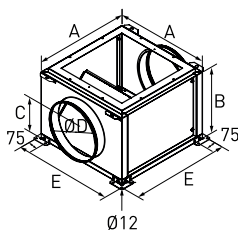
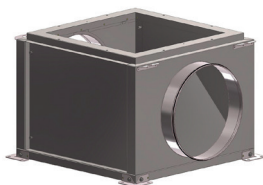

- **ILPL**
- plenum box se 2 hrdly
- na sání
- pro provedení MV

Typ	A [mm]	B [mm]	C [mm]	D [mm]	E [mm]	hmot. [kg]
ILPL 355	622	448	238	355	662	21
ILPL 400	694	498	260	400	734	25
ILPL 450	774	555	289	450	814	30
ILPL 500	852	675	349	560	892	37
ILPL 560	948	755	389	630	988	60
ILPL 630	1060	805	441	630	1100	81
ILPL 710	1188	885	481	710	1228	99

ILHT CC, ILHT MV – příslušenství

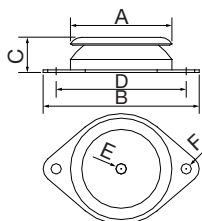
KSE-PAVZ

- silentbloky
- 4 ks

14

Typ	velikost ILHT	A [mm]	B [mm]	C [mm]	D [mm]	Ø E [mm]	Ø F [mm]
KSE-PAVZ-60 SH 75	ILHT 355-450	60	90	24	76	M6	6,2
KSE-PAVZ-80 SH 60	ILHT 500-630	80	120	27	100	M8	8,2
KSE-PAVZ-150 SH 60	ILHT 710, 800	150	214	39	182	M14	12,2

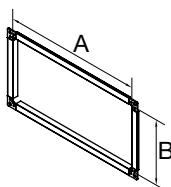
ILBR

- příruba

Typ	A [mm]	B [mm]
ILBR 355	559	263
ILBR 400	631	297
ILBR 450	711	326
ILBR 500	768	338
ILBR 560	864	354
ILBR 630	977	403
ILBR 710	1104	462
ILBR 800	1248	488

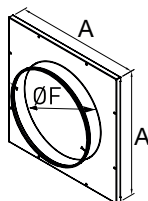
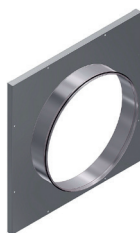
ILBC

- kruhové hrdlo na sání
- pro provedení MV

Typ	A [mm]	F [mm]
ILBC 355	559	400
ILBC 400	631	450
ILBC 450	711	500
ILBC 500	768	560
ILBC 560	864	630
ILBC 630	977	710
ILBC 710	1104	800
ILBC 800	1248	900

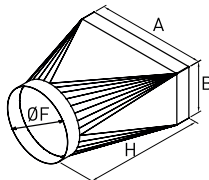
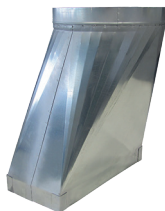
ILRC

- přechod na kruhové potrubí
- na výtlak

Typ	A [mm]	B [mm]	F [mm]	H [mm]
ILRC 355	559	266	400	670
ILRC 400	631	300	450	670
ILRC 450	711	329	500	670
ILRC 500	768	341	560	670
ILRC 560	864	357	630	670
ILRC 630	977	406	710	670
ILRC 710	1104	465	800	670
ILRC 800	1248	491	900	670

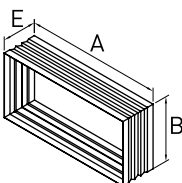
ILAR

- pružná manžeta

Typ	A [mm]	B [mm]	E [mm]
ILAR 355	559	266	160
ILAR 400	631	300	160
ILAR 450	711	329	160
ILAR 500	768	341	160
ILAR 560	864	357	160
ILAR 630	977	406	160
ILAR 710	1104	465	160
ILAR 800	1248	491	160

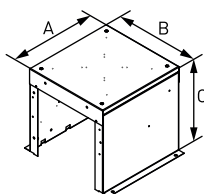
ILTM

- kryt motoru
- pro motor v horizontální poloze

Typ	A [mm]	B [mm]	C [mm]
ILTM 355 - 450	340	325	305
ILTM 500 - 630	415	475	355
ILTM 710, 800	510	465	450

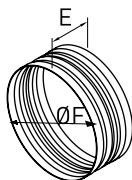
ACOPEL F400 N

- pružná manžeta kruhová

Typ	E [mm]	F [mm]
ACOPEL 355 N	160	400
ACOPEL 400 N	160	450
ACOPEL 450 N	160	500
ACOPEL 500 N	160	560
ACOPEL 560 N	160	630
ACOPEL 630 N	160	710
ACOPEL 710 N	160	800
ACOPEL 800 N	160	900

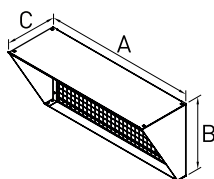
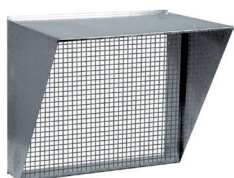
ILVH

- ochranná mřížka výtlačku

Typ	A [mm]	B [mm]	C [mm]
ILVH 355	559	263	197
ILVH 400	631	297	216
ILVH 450	711	326	233
ILVH 500	768	338	240
ILVH 560	864	354	250
ILVH 630	977	403	278
ILVH 710	1104	462	311
ILVH 800	1248	488	328

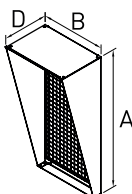
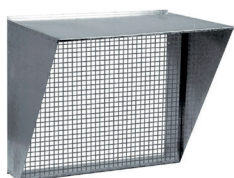
ILVV

- ochranná mřížka výtlačku

Typ	A [mm]	B [mm]	D [mm]
ILVV 355	559	263	194
ILVV 400	631	297	213
ILVV 450	711	326	234
ILVV 500	768	338	249
ILVV 560	864	354	275
ILVV 630	977	403	305
ILVV 710	1104	462	340
ILVV 800	1248	488	378

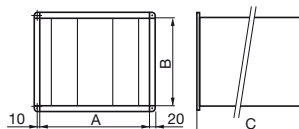
**IAA-ILHT**

- jednoduché připojení ke čtyřhrannému potrubí
- v případě vyšších požadavků na snížení hladiny hluku doporučujeme spojit dva nebo více tlumičů do série
- hodnoty tlakových ztrát a vložného útlu-mu na vyžádání

Typ	rozměr potrubí [mm]	A [mm]	B [mm]	C [mm]
IAA-ILHT 355	559x263	559	263	1000
IAA-ILHT 400	631x297	631	297	1000
IAA-ILHT 450	711x326	711	326	1000
IAA-ILHT 500	768x338	768	338	1000
IAA-ILHT 560	864x354	864	354	1000
IAA-ILHT 630	977x403	977	403	1000
IAA-ILHT 710	1104x462	1104	462	1000
IAA-ILHT 800	1248x488	1248	488	1000

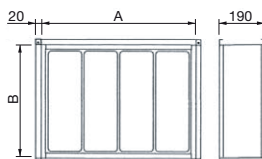
**IFLK-ILHT**

- filtrační kazeta pro čtyřhranné potrubí je standardně vybavena deskovým filtrem G4, filtr je součástí kazety
- kazeta je vyrobena z galvanizované oceli
- filtr se vyjímá dvířky, nutno pamatovat na volný prostor pro otevření dvířek a výměnu filtru
- na skříni mohou být osazeny odběry pro diferenciální tlakový senzor, kterým lze indikovat zanesení filtru
- IFRK – náhradní filtrační vložka

Typ	rozměr potrubí [mm]	A [mm]	B [mm]
IFLK-ILHT 355	559x263	559	526
IFLK-ILHT 400	631x297	631	594
IFLK-ILHT 450	711x326	711	652
IFLK-ILHT 500	768x338	768	676
IFLK-ILHT 560	864x354	864	708
IFLK-ILHT 630	977x403	977	806
IFLK-ILHT 710	1104x462	1104	924
IFLK-ILHT 800	1248x488	1248	976

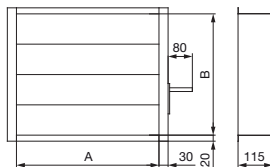
**IJK-ILHT**

- slouží k regulování soustavy
- po sejmutí ruční regulační páky s aretační maticí polohy je připravena pro servopohon

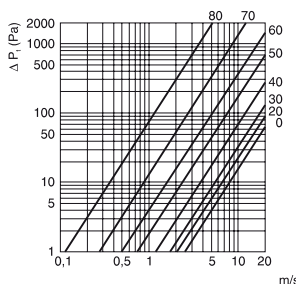

Typ	rozměr potrubí [mm]	A [mm]	B [mm]
IJK-ILHT 355	559x263	559	263
IJK-ILHT 400	631x297	631	297
IJK-ILHT 450	711x326	711	326
IJK-ILHT 500	768x338	768	338
IJK-ILHT 560	864x354	864	354
IJK-ILHT 630	977x403	977	403
IJK-ILHT 710	1104x462	1104	462
IJK-ILHT 800	1248x488	1248	488